

Dimensiones de gabinete
Cabinet Dimensions

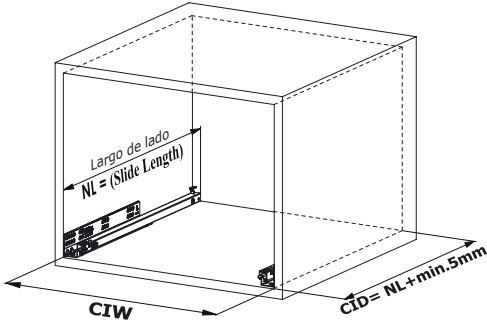

CIW : Cabinet Internal Width / Ancho interno del gabinete
CID : Cabinet Internal Depth / Profundidad interna de gabinete
DD : Drawer Depth / Profundidad de cajón
DIW : Drawer Internal Width / Ancho interno de cajón
NL : Nominal Length / Largo nominal

Tornillos y plantillas recomendadas

Recommended Screw and Templates

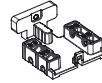
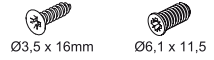

Plantilla de bloqueo inteligente
Smart Lock Template

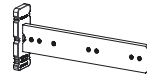

Plantilla inteligente de perforación
Smart Drilling Jig



Plantilla inteligente de perforación con regla
Smart Drilling Jig with Ruler

Locación de tornillos para los lados
Screw Location for the Slides

Atornilla el lado por los hoyos marcados
Screw the slide from marked holes.

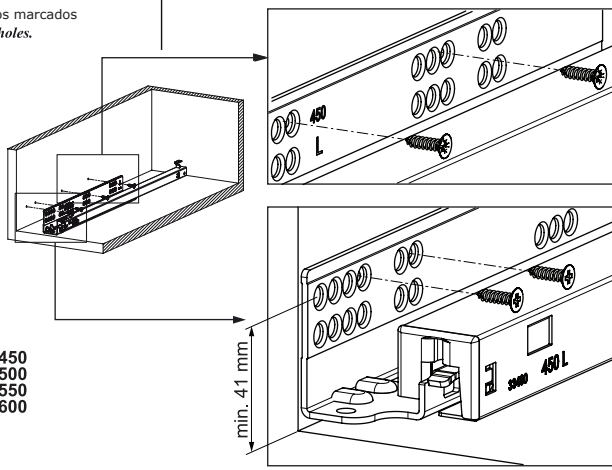
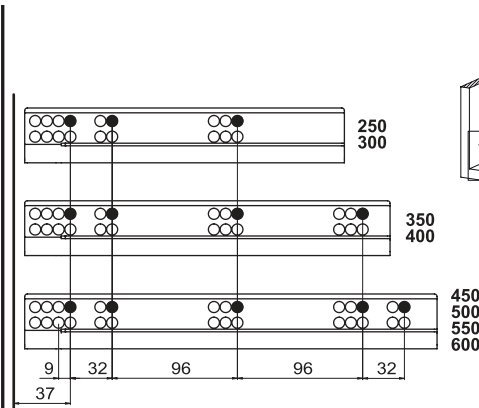

Dimensiones de cajón
Drawer Dimensions

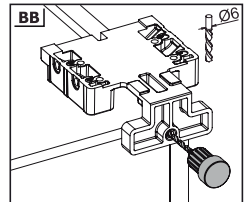
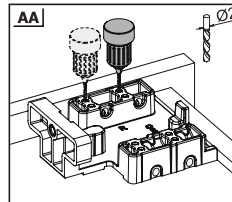
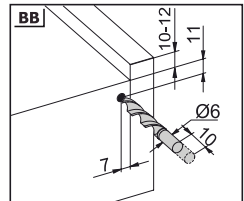
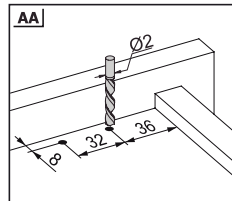
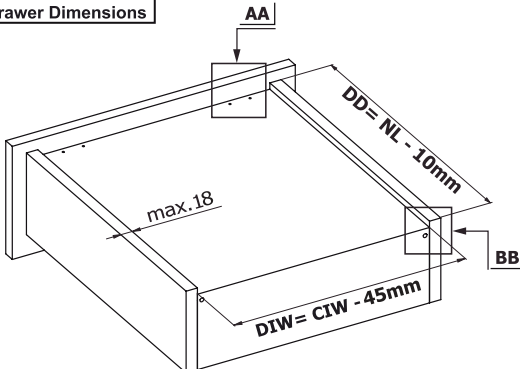

1

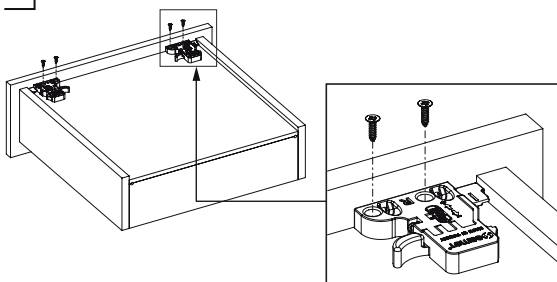

Nota: Usa los hoyos en ángulo para montar el cerrado inteligente cuando el ancho de piso de madera seleccionado es menor que 12 mm.

Note: Use angled holes to mount smart lock when wooden floor width is selected less than 12 mm.

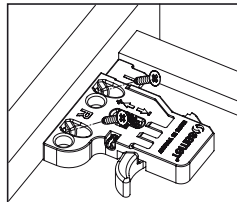
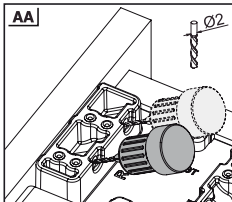

2

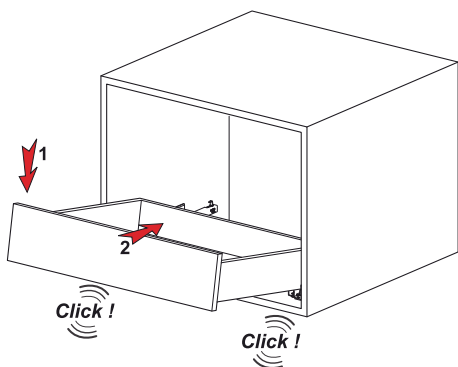

3

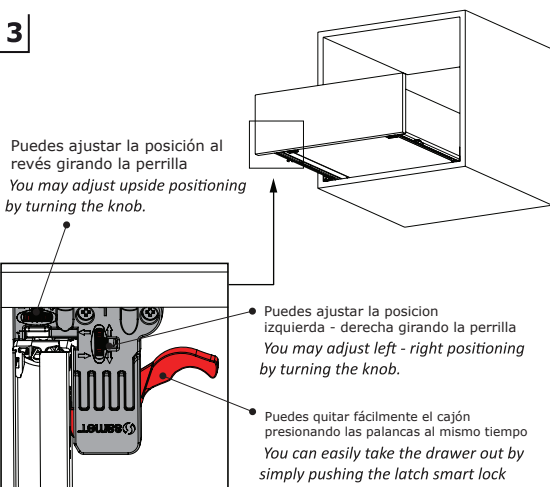

Plantilla inteligente de perforación
Smart Drilling Jig

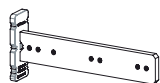

Kod / Code

12799902

12799904

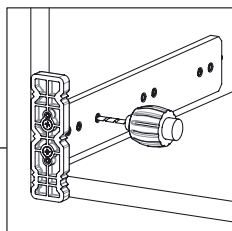
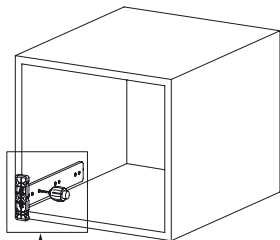

Plantilla inteligente de perforación con regla
Smart Drilling Jig with Ruler



Código / Code

12799901

12799905

